

**8-axis Position Controller for RoboCylinder
RCP6/RCP5/RCP4/RCP3/RCP2/RCA2/RCA/RCD**

MCON



**1 unit can control the pulse motor,
AC servo motor, and brush-less DC motor**

**8-axis controller that achieves the
small size and high functionality**



1 Saves space and reduces cost

It saves space in the control panel and significantly reduces the total cost by combining 8 controllers into one.

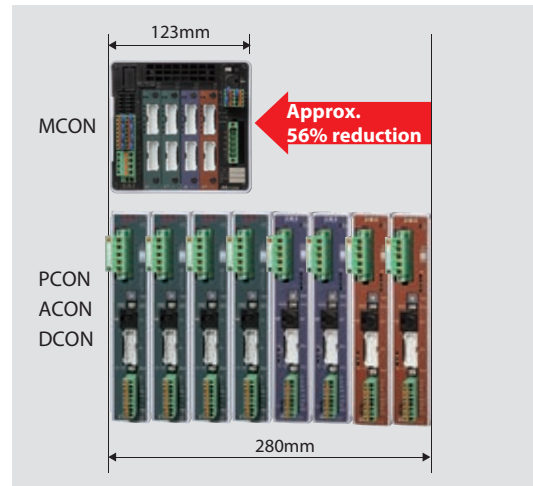

2 Accommodates a wide range of actuators

It corresponds to actuators with battery-less absolute encoders, ultra-compact micro cylinders, multi-rotation rotaries and the like, expanding the operable actuators from small to large. In addition, it is equipped with the PowerCon (high-output driver), and achieves the maximum speed of 1.5 times higher and maximum load capacity of over 2 times higher than the conventional models by using in combination with the RCP6/RCP5/RCP4.

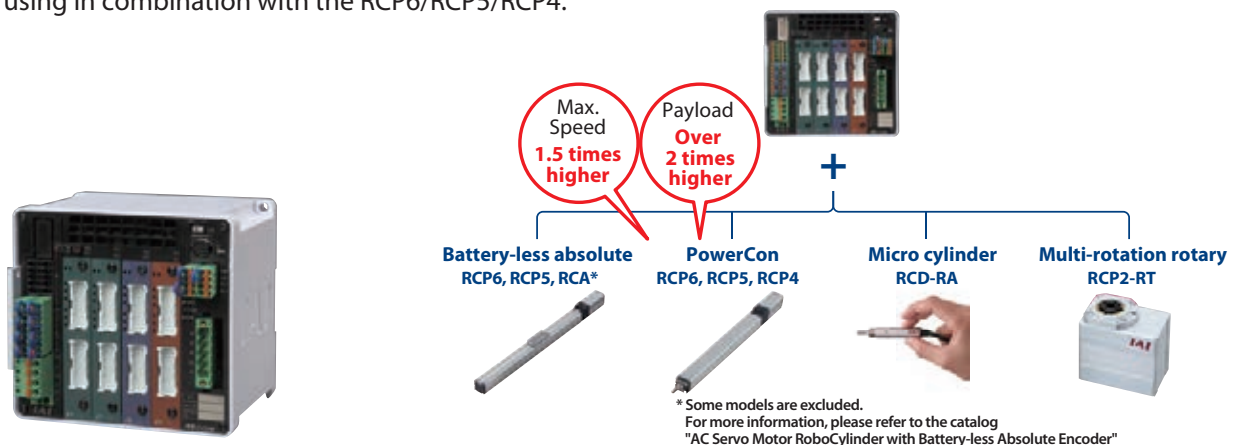

Allows the installation of 7 types of driver boards

- (1) Battery-less absolute/incremental driver boards for pulse motor
- (2) Simple absolute driver board for pulse motor
- (3) Battery-less absolute/incremental driver boards for PowerCon
- (4) Simple absolute driver board for PowerCon
- (5) Battery-less absolute/incremental driver boards for 24VAC servo motor
- (6) Simple absolute driver board for 24VAC servo motor
- (7) Incremental driver board for brush-less DC servo motor



3 Allows the servo monitoring in the AUTO mode

The AUTO mode status monitoring and servo monitoring that were only supported by single-axis controllers can now be performed using multi-axis controllers. In addition, the monitoring can start from the moment that the condition of a selected signal changed. (Trigger function)
You can easily save the data to be monitored.

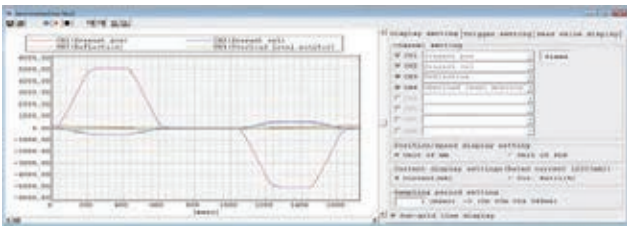

4 The calendar function allows the alarm occurrence time to be retained

With the addition of the clock function, the alarm history is displayed with the time of occurrence, making it easier for the alarm to be analyzed. (The retention period of the time data is 10 days after the power is cut.)
The number of alarms stored in the history is up to 32 per axis.

Axis	Alarm Type	Time of Occurrence
Axis 1	Positioning Error	2023.10.27 10:30:15
Axis 2	Velocity Error	2023.10.27 10:30:15
Axis 3	Acceleration Error	2023.10.27 10:30:15
Axis 4	Deceleration Error	2023.10.27 10:30:15
Axis 5	Positioning Error	2023.10.27 10:30:15
Axis 6	Velocity Error	2023.10.27 10:30:15
Axis 7	Acceleration Error	2023.10.27 10:30:15
Axis 8	Deceleration Error	2023.10.27 10:30:15
Axis 9	Positioning Error	2023.10.27 10:30:15
Axis 10	Velocity Error	2023.10.27 10:30:15
Axis 11	Acceleration Error	2023.10.27 10:30:15
Axis 12	Deceleration Error	2023.10.27 10:30:15
Axis 13	Positioning Error	2023.10.27 10:30:15
Axis 14	Velocity Error	2023.10.27 10:30:15
Axis 15	Acceleration Error	2023.10.27 10:30:15
Axis 16	Deceleration Error	2023.10.27 10:30:15
Axis 17	Positioning Error	2023.10.27 10:30:15
Axis 18	Velocity Error	2023.10.27 10:30:15
Axis 19	Acceleration Error	2023.10.27 10:30:15
Axis 20	Deceleration Error	2023.10.27 10:30:15
Axis 21	Positioning Error	2023.10.27 10:30:15
Axis 22	Velocity Error	2023.10.27 10:30:15
Axis 23	Acceleration Error	2023.10.27 10:30:15
Axis 24	Deceleration Error	2023.10.27 10:30:15
Axis 25	Positioning Error	2023.10.27 10:30:15
Axis 26	Velocity Error	2023.10.27 10:30:15
Axis 27	Acceleration Error	2023.10.27 10:30:15
Axis 28	Deceleration Error	2023.10.27 10:30:15
Axis 29	Positioning Error	2023.10.27 10:30:15
Axis 30	Velocity Error	2023.10.27 10:30:15
Axis 31	Acceleration Error	2023.10.27 10:30:15
Axis 32	Deceleration Error	2023.10.27 10:30:15

5 Many useful functions

Smart tuning function (for pulse motor)

- The optimum acceleration and deceleration are set according to the payload to be conveyed.

Off-board tuning function (for 24VAC servo motor)

- The optimum gain is set according to the payload.

Vibration control function (for 24VAC servo motor)

- It reduces the shaking (vibration) of the workpiece attached to the slider.

Acceleration/deceleration mode specification

- The acceleration and deceleration patterns can be specified from the trapezoid pattern, first-order delay filter and S-shaped motion.

Axis name display function

- The axis name can be displayed in the PC compatible software and touch panel teaching box.

6 It can be moved by specified values via fieldbus

- The number of positioning points per axis is 256.
- It can be operated by specifying the position to reach and speed in numerical values.
- The current position can be checked in real time.



Details of MCON Slots

(1) MCON has 4 slots:

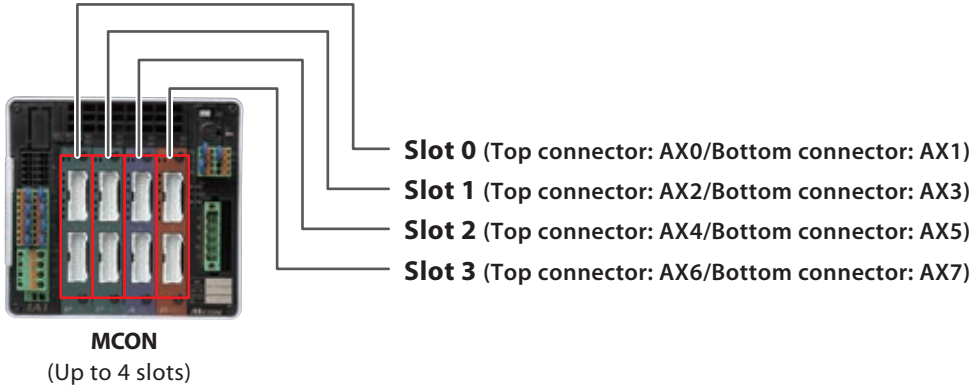

(2) How to fill out the model name for each slot:

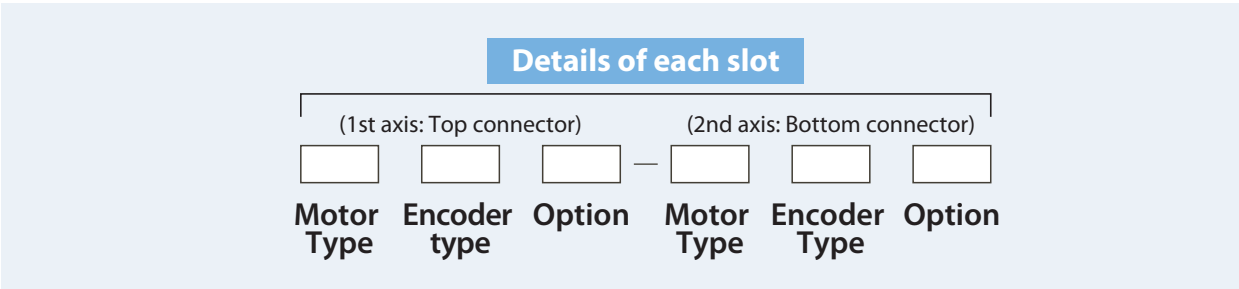

- One driver board is used per one slot, and different motor types (Pulse motor/24VAC servo motor/Brush-less DC motor) or different encoder types (WAI/SA/I) cannot be connected on the same driver board.
- Depending on the type of actuator, there are those that allow for 2 axes to be connected to 1 slot or only allow for 1 axis to be connected.

Number of axes that can be connected to 1 slot	Actuator type
1 axis	RCP6, RCP5, RCP4 (with enabled high-output setting for each series)
2 axes	RCP6, RCP5, RCP4 (with disabled high-output setting for each series); RCP3, RCP2, RCA2, RCA, RCD

- If only 1 axis is connected to 1 slot, the model name of the second axis/bottom connector will be "N".
- When using RCP6/RCP5/RCP4 with high-output setting enabled, please enter "T" in the option column.

■ Entry examples for each slot

E.g. 1 When connecting 3 axes of RCP5-SA4C-WA-35P (high-output setting enabled)

Slot 0	Slot 1	Slot 2
35PWAIT-N-35PWAIT-N-35PWAIT-N		









E.g. 2 When connecting 2 axes of RCA-SA5C-I-20 or 1 axis of RCD-RA1DA-I-3

Slot 0	Slot 1
20WAI-20WAI-3DI-N	

Please refer to the next page for the combination examples of each axis.

MCON Driver Board Combination Examples

The table below shows driver board combination examples of MCON-C/CG.

Combination Examples	Model Names of the Connected Actuators	Number of axes
 <p>RCP5-SA6C RCP5-RA4C</p>	1st axis: RCP5-SA6C-WA-42P PowerCon/Battery-less abs. 2nd axis: RCP5-RA4C-WA-35P PowerCon/Battery-less abs.	2
 <p>RCP5-SA6C RCP5-RA4C RCA-SA6C</p>	1st axis: RCP5-SA6C-WA-42P Pulse motor/Battery-less abs. 2nd axis: RCP5-RA4C-WA-35P Pulse motor/Battery-less abs. 3rd axis: RCA-SA6C-WA-30 AC servo/Battery-less abs.	3
 <p>RCP5-SA4C RCP5-RA4C</p>	1st axis: RCP5-SA4C-WA-35P PowerCon/Battery-less abs. 2nd axis: RCP5-SA4C-WA-35P PowerCon/Battery-less abs. 3rd axis: RCP5-RA4C-WA-35P PowerCon/Battery-less abs. 4th axis: RCP5-RA4C-WA-35P PowerCon/Battery-less abs.	4
 <p>RCP5-SA4C RCA2-TCA4NA RCD-RA1DA</p>	1st axis: RCP5-SA4C-WA-35P PowerCon/Battery-less abs. 2nd axis: RCP5-SA4C-WA-35P Pulse motor/Battery-less abs. 3rd axis: RCA2-TCA4NA-I-20 AC servo motor/Simple abs. 4th axis: RCD-RA1DA-I-3D BLDC servo motor/Incremental	4
 <p>RCP5-SA6 RCP5-RA4C RCA2-TCA4NA RCD-RA1DA</p>	1st axis: RCP5-SA6C-WA-42P PowerCon/Battery-less abs. 2nd axis: RCP5-RA4C-WA-35P Pulse motor/Battery-less abs. 3rd axis: RCP5-RA4C-WA-35P Pulse motor/Battery-less abs. 4th axis: RCA2-TCA4NA-I-20 AC servo motor/Simple abs. 5th axis: RCD-RA1DA-I-3D BLDC servo motor/Incremental	5
 <p>RCP5-RA4C RCA2-TCA4NA RCD-RA1DA</p>	1st/2nd axes: RCP5-RA4C-WA-35P Pulse motor/Battery-less abs. 3rd/4th axes: RCA2-TCA4NA-I-20 AC servo motor/Incremental 5th/6th axes: RCD-RA1DA-I-3D BLDC servo motor/Incremental	6
 <p>RCP5-RA4C</p>	1st~7th axes: RCP5-RA4C-WA-35P Pulse motor/Battery-less abs.	7
 <p>RCP5-RA4C RCA2-TCA4NA RCD-RA1DA</p>	1st/2nd axes: RCP5-RA4C-WA-35P Pulse motor/Battery-less abs. 3rd/4th axes: RCA2-TCA4NA-I-20 AC servo motor/Simple abs. 5th~8th axes: RCD-RA1DA-I-3D BLDC servo motor/Incremental	8

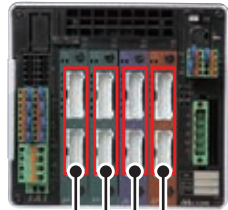

Note: RCD series does not support the simple absolute specification.

Slot 0	Slot 1	Slot 2	Slot 3	Model Number
AX0	AX2	AX4	AX6	<p>MCON-C-2-42PWAIT-N-35PWAIT-N-DV-0-0</p>
PowerCon 42 <input type="checkbox"/> Battery-less abs.	PowerCon 35 <input type="checkbox"/> Battery-less abs.	Not in use (Available)	Not in use (Available)	
AX1	AX3	AX5	AX7	
Reserved by PowerCon (Unavailable)	Reserved by PowerCon (Unavailable)	Not in use (Available)	Not in use (Available)	
AX0	AX2	AX4	AX6	<p>MCON-C-3-42PWAI-35PWAI-30WAI-N-DV-0-0</p>
Pulse motor 42 <input type="checkbox"/> Battery-less abs.	AC servo motor 30W Battery-less absolute	Not in use (Available)	Not in use (Available)	
AX1	AX3	AX5	AX7	
Pulse motor 35 <input type="checkbox"/> Battery-less abs.	Reserved by PowerCon (Unavailable)	Not in use (Available)	Not in use (Available)	
AX0	AX2	AX4	AX6	<p>MCON-C-4-35PWAIT-N-35PWAIT-N-35PWAIT-N-35PWAIT-N-DV-0-0</p>
PowerCon 35 <input type="checkbox"/> Battery-less abs.	PowerCon 35 <input type="checkbox"/> Battery-less abs.	PowerCon 35 <input type="checkbox"/> Battery-less abs.	PowerCon 35 <input type="checkbox"/> Battery-less abs.	
AX1	AX3	AX5	AX7	
Reserved by PowerCon (Unavailable)	Reserved by PowerCon (Unavailable)	Reserved by PowerCon (Unavailable)	Reserved by PowerCon (Unavailable)	
AX0	AX2	AX4	AX6	<p>MCON-C-4-35PWAIT-N-35PWAI-N-20SA-N-3DI-N-DV-0-0-ABB</p>
PowerCon 35 <input type="checkbox"/> Battery-less abs.	Pulse motor 35 <input type="checkbox"/> Battery-less abs.	AC servo motor 20W Simple absolute	BLDC servo motor Incremental	
AX1	AX3	AX5	AX7	
Reserved by PowerCon (Unavailable)	Reserved by PowerCon (Unavailable)	Reserved by PowerCon (Unavailable)	Reserved by PowerCon (Unavailable)	
AX0	AX2	AX4	AX6	<p>MCON-C-5-42PWAIT-N-35PWAI-35PWAI-20SA-N-3DI-N-DV-0-0-ABB</p>
PowerCon 42 <input type="checkbox"/> Battery-less abs.	Pulse motor 35 <input type="checkbox"/> Battery-less abs.	AC servo motor 20W Simple absolute	BLDC servo motor Incremental	
AX1	AX3	AX5	AX7	
Reserved by PowerCon (Unavailable)	Pulse motor 35 <input type="checkbox"/> Battery-less abs.	Reserved by PowerCon (Unavailable)	Not in use (Available)	
AX0	AX2	AX4	AX6	<p>MCON-C-6-35PWAI-35PWAI-20WAI-20WAI-3DI-3DI-DV-0-0</p>
Pulse motor 35 <input type="checkbox"/> Battery-less abs.	AC servo motor 20W Incremental	BLDC servo motor Incremental	Not in use (Available)	
AX1	AX3	AX5	AX7	
Pulse motor 35 <input type="checkbox"/> Battery-less abs.	AC servo motor 20W Incremental	BLDC servo motor Incremental	Not in use (Available)	
AX0	AX2	AX4	AX6	<p>MCON-C-7-35PWAI-35PWAI-35PWAI-35PWAI-35PWAI-35PWAI-N-DV-0-0</p>
Pulse motor 35 <input type="checkbox"/> Battery-less abs.	Pulse motor 35 <input type="checkbox"/> Battery-less abs.	Pulse motor 35 <input type="checkbox"/> Battery-less abs.	Pulse motor 35 <input type="checkbox"/> Battery-less abs.	
AX1	AX3	AX5	AX7	
Pulse motor 35 <input type="checkbox"/> Battery-less abs.	Pulse motor 35 <input type="checkbox"/> Battery-less abs.	Pulse motor 35 <input type="checkbox"/> Battery-less abs.	Reserved by PowerCon (Unavailable)	
AX0	AX2	AX4	AX6	<p>MCON-C-8-35PWAI-35PWAI-20SA-20SA-3DI-3DI-3DI-3DI-DV-0-0-ABB</p>
Pulse motor 35 <input type="checkbox"/> Battery-less abs.	AC servo motor 20W Simple absolute	BLDC servo motor Incremental	BLDC servo motor Incremental	
AX1	AX3	AX5	AX7	
Pulse motor 35 <input type="checkbox"/> Battery-less abs.	AC servo motor 20W Simple absolute	BLDC servo motor Incremental	BLDC servo motor Incremental	

Standard Price Chart

Calculate the standard price of the MCON controller based on (1) base price by type as specified below, by adding (2) slot model price, (3) quantity of simple absolute, (4) quantity of batteries for simple absolute, and (5) I/O type.

(1) Base price by type

Select the standard type (MCON-C) or safety category compliant type (MCON-CG).

+

(2) Slot model price

Add the price of the slot types specified in the 0~3 slots.

(1)		
Base price by type		
Description	Model number	Price
Standard	MCON-C	
Safety category compliant type	MCON-CG	

+

(2)				
Slot model price (Add the total amount of slots to be used)				
Details of slot			Model number	Price
Pulse motor	1-axis	Battery-less absolute/ Incremental (For PowerCon)	<input type="checkbox"/> PWAIT-N	
		Simple absolute (For PowerCon)	<input type="checkbox"/> PSAT-N	
		Battery-less absolute/ Incremental (For standard)	<input type="checkbox"/> PWAI-N	
		Simple absolute (For standard)	<input type="checkbox"/> PSA-N	
	2-axis	Simple absolute (For standard) + Simple absolute (For standard)	<input type="checkbox"/> PSA- <input type="checkbox"/> PSA	
		Battery-less abs./Incremental (For standard) + Battery-less abs./Incremental (For standard)	<input type="checkbox"/> PWAI- <input type="checkbox"/> PWAI	
AC servo motor	1-axis	Battery-less absolute/ Incremental (For standard)	<input type="checkbox"/> WAI-N	
		Simple absolute (For standard)	<input type="checkbox"/> SA-N	
	2-axis	Battery-less abs./Incremental (For standard) + Battery-less abs./Incremental (For standard)	<input type="checkbox"/> WAI- <input type="checkbox"/> WAI	
		Simple absolute (For standard) + Simple absolute (For standard)	<input type="checkbox"/> SA- <input type="checkbox"/> SA	
BLDC servo motor	1-axis	Incremental (For standard)	3DI-N	
	2-axis	Incremental (For standard) + Incremental (For standard)	3DI-3DI	

* indicates the motor size.

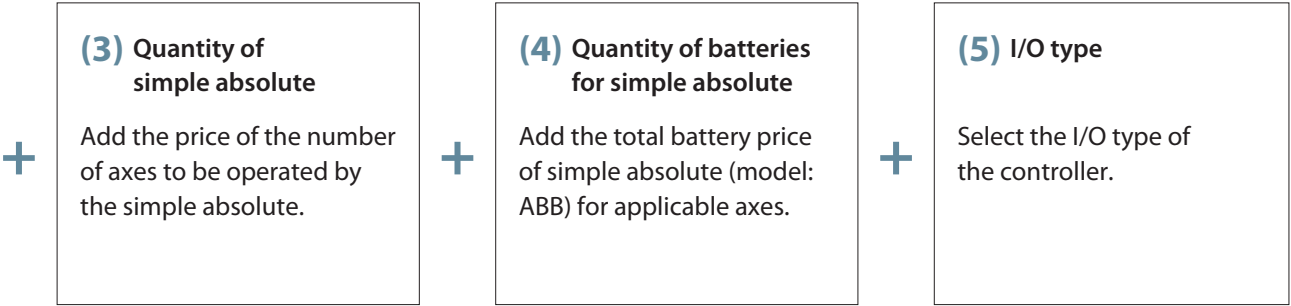

	(3)	(4)	(5)																																																													
	Quantity of simple absolute	Quantity of batteries for simple absolute	I/O Type	Price																																																												
	<table border="1" style="width: 100%; border-collapse: collapse;"> <thead> <tr> <th style="width: 50%;">Number of axes</th> <th style="width: 50%;">Price</th> </tr> </thead> <tbody> <tr><td>1-axis</td><td></td></tr> <tr><td>2-axis</td><td></td></tr> <tr><td>3-axis</td><td></td></tr> <tr><td>4-axis</td><td></td></tr> <tr><td>5-axis</td><td></td></tr> <tr><td>6-axis</td><td></td></tr> <tr><td>7-axis</td><td></td></tr> <tr><td>8-axis</td><td></td></tr> </tbody> </table>	Number of axes	Price	1-axis		2-axis		3-axis		4-axis		5-axis		6-axis		7-axis		8-axis		<table border="1" style="width: 100%; border-collapse: collapse;"> <thead> <tr> <th style="width: 50%;">Number of axes</th> <th style="width: 50%;">Price</th> </tr> </thead> <tbody> <tr><td>1-axis</td><td></td></tr> <tr><td>2-axis</td><td></td></tr> <tr><td>3-axis</td><td></td></tr> <tr><td>4-axis</td><td></td></tr> <tr><td>5-axis</td><td></td></tr> <tr><td>6-axis</td><td></td></tr> <tr><td>7-axis</td><td></td></tr> <tr><td>8-axis</td><td></td></tr> </tbody> </table>	Number of axes	Price	1-axis		2-axis		3-axis		4-axis		5-axis		6-axis		7-axis		8-axis		<table border="1" style="width: 100%; border-collapse: collapse;"> <thead> <tr> <th style="width: 33%;">Type</th> <th style="width: 33%;">Model number</th> <th style="width: 33%;">Price</th> </tr> </thead> <tbody> <tr><td>DeviceNet connection specification</td><td>DV</td><td></td></tr> <tr><td>CC-Link connection specification</td><td>CC</td><td></td></tr> <tr><td>PROFIBUS-DP connection specification</td><td>PR</td><td></td></tr> <tr><td>CompoNet connection specification</td><td>CN</td><td></td></tr> <tr><td>EtherCAT connection specification</td><td>EC</td><td></td></tr> <tr><td>EtherNet/IP connection specification</td><td>EP</td><td></td></tr> <tr><td>PROFINET IO connection specification</td><td>PRT</td><td></td></tr> </tbody> </table>	Type	Model number	Price	DeviceNet connection specification	DV		CC-Link connection specification	CC		PROFIBUS-DP connection specification	PR		CompoNet connection specification	CN		EtherCAT connection specification	EC		EtherNet/IP connection specification	EP		PROFINET IO connection specification	PRT		=
Number of axes	Price																																																															
1-axis																																																																
2-axis																																																																
3-axis																																																																
4-axis																																																																
5-axis																																																																
6-axis																																																																
7-axis																																																																
8-axis																																																																
Number of axes	Price																																																															
1-axis																																																																
2-axis																																																																
3-axis																																																																
4-axis																																																																
5-axis																																																																
6-axis																																																																
7-axis																																																																
8-axis																																																																
Type	Model number	Price																																																														
DeviceNet connection specification	DV																																																															
CC-Link connection specification	CC																																																															
PROFIBUS-DP connection specification	PR																																																															
CompoNet connection specification	CN																																																															
EtherCAT connection specification	EC																																																															
EtherNet/IP connection specification	EP																																																															
PROFINET IO connection specification	PRT																																																															
				Standard price by specification																																																												

*No need to add (3) and (4) for the battery-less absolute type.

System Configuration

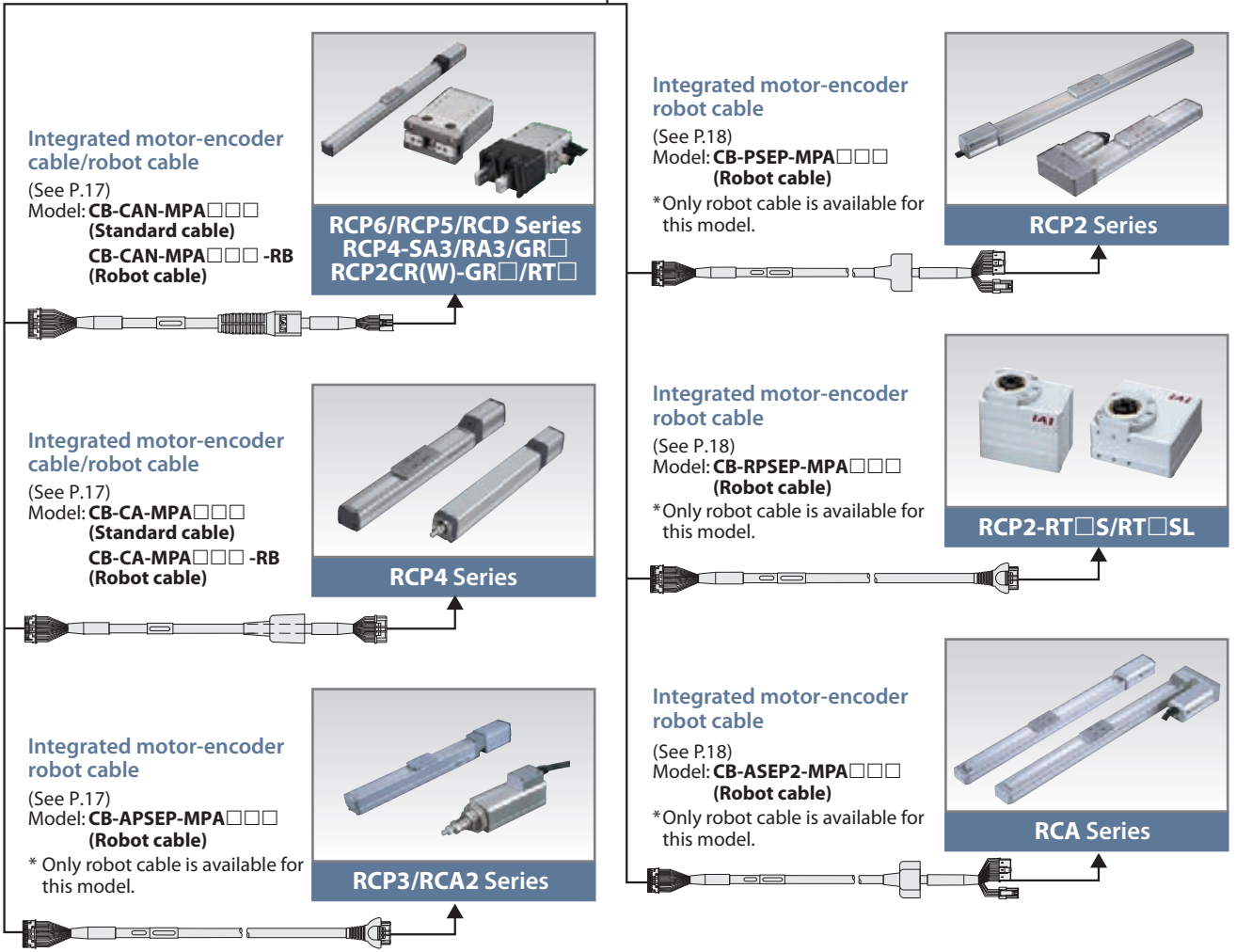
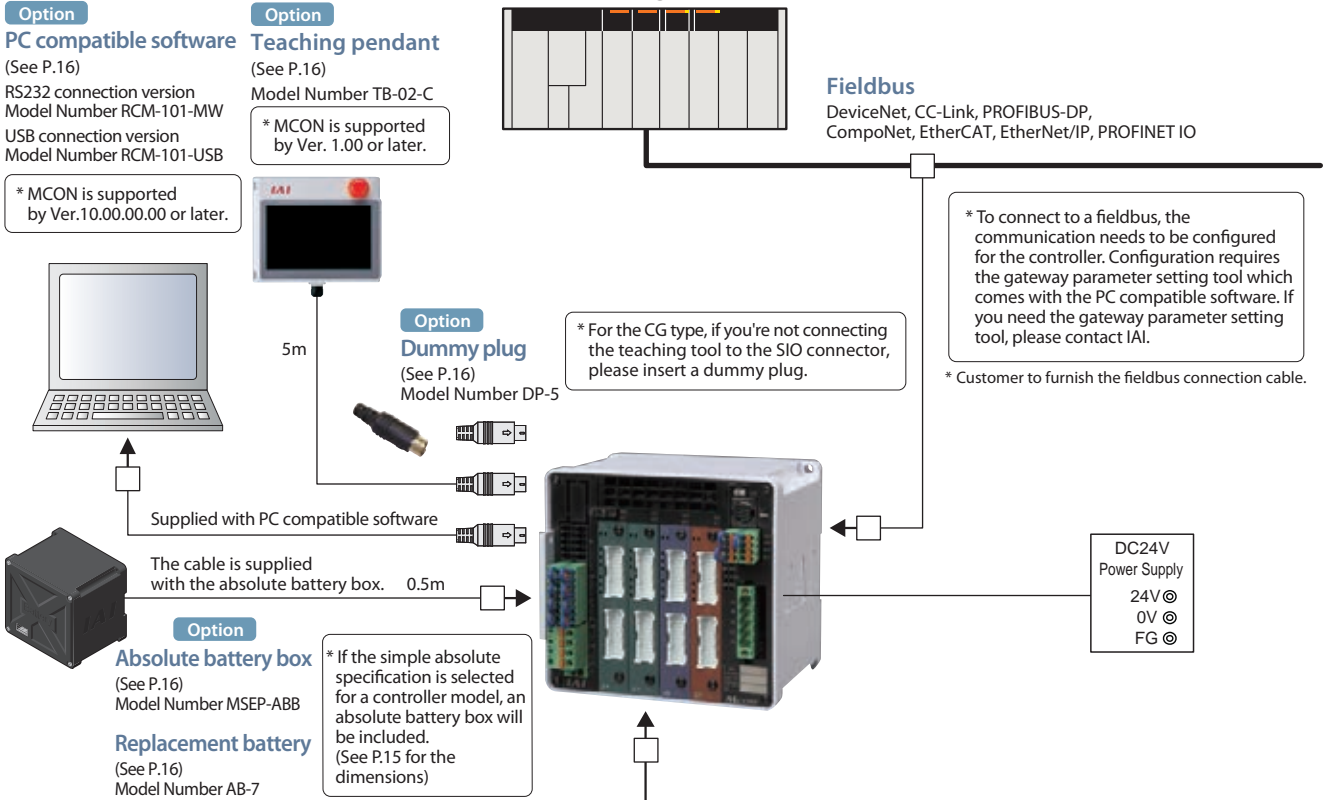

Fieldbus Control Operation Modes

The MCON fieldbus control operation mode can be set from the following control modes. Data required for operation (target position, speed, acceleration, push current value, etc.) are written by a PLC or other host controller into the specified addresses.

Operation mode	Description	Overview
Positioner 1 / Simple direct numerical value mode (Simple direct mode)	Positioner 1 mode can store up to 256 points of position data, and can move to the stored position. Both modes allow monitoring the current position numerically with 0.01mm increments. The simple direct numerical value mode can modify any of the stored target positions by numerical value. Both modes allow monitoring the current position numerically with 0.01mm increments.	
Direct numerical control mode	This mode allows designating the target position, speed, acceleration/deceleration, and motor current percentage for pushing numerically. Also, it is capable of monitoring the current position, current speed, and the motor current command value with 0.01mm increments.	
Positioner 2 mode	Positioner 2 mode can store up to 256 points of position data, and can move to the stored position. This mode does not allow monitoring of the current position. This is a mode that has less in/out data transfer volume than the Positioner 1 mode.	
Positioner 3 mode	Positioner 3 mode can store up to 256 points of position data, and can move to the stored position. This mode does not allow monitoring of the current position. This is a mode that has less in/out data transfer volume than the Positioner 2 mode, and operates with a minimum number of signals.	
Positioner 5 mode	Positioner 5 mode can store up to 16 points of position data, and can move to the stored position. This is a mode that has less in/out data transfer volume than the Positioner 2 mode, and allows monitoring the current position numerically with 0.1mm increments.	
Remote I/O mode	It is an operation mode that's controlled by the ON/OFF of the digital I/Os similar to the PIO ribbon cable. There are 5 control modes available (See P.11). *Different PIO patterns can be set in the parameters.	

* Only the positioner 3 mode and remote I/O mode can be selected for the CompoNet.

* Please note that if the remote I/O mode is selected, all axes will be in the remote I/O mode.

List of Functions by Operation Mode

	Simple direct value mode	Positioner 1 mode	Direct numerical control mode	Positioner 2 mode	Positioner 3 mode	Positioner 5 mode
Number of positioning points	256 points	256 points	Unlimited	256 points	256 points	16 points
Home return operation	○	○	○	○	○	○
Positioning operation	○	△	○	△	△	△
Speed, acceleration/ deceleration settings	△	△	○	△	△	△
Different acceleration and deceleration settings	△	△	—	△	△	△
Pitch feed (Incremental)	△	△	○	△	—	△
Push-motion operation	△	△	○	△	△	△
Speed changes while moving	△	△	○	△	△	△
Pausing	○	○	○	○	○	○
Zone signal output	△	△	△	△	△	△
Position zone signal output	△	△	—	△	—	—
Vibration control (Note 1)	△	△	—	△	△	△
Current position reading (Resolution)	○ (0.01mm)	○ (0.01mm)	○ (0.01mm)	—	—	○ (0.1mm)

* ○: Direct setting is possible, △: Position data or parameter input is required, —: The operation is not supported.
 (Note 1) This function is limited to the 24VAC servo motor specification.

Functions of RoboCylinder	Remote I/O mode				
	Positioning mode	Teaching mode	256-point mode	Solenoid valve mode 1	Solenoid valve mode 2
Number of positioning points	64 points	64 points	256 points	7 points	3 points
Home return operation	○	○	○	○	— (Note 2)
Positioning operation	○	○	○	○	○
Speed, acceleration/ deceleration settings	○	○	○	○	○
Different acceleration and deceleration settings	○	○	○	○	○
Pitch feed (Incremental)	○	○	○	○	—
Push-motion operation	○	○	○	○	—
Speed changes while moving	○	○	○	○	○
Pausing	○	○	○	○	○ (Note 3)
Zone signal output	○	○ (Note 4)	○ (Note 4)	○	○
Position zone signal output	○ (Note 4)	○ (Note 4)	○ (Note 4)	○ (Note 4)	○ (Note 4)
Vibration control (Note 1)	○	○	○	○	○
Current position reading	—	—	—	—	—

* ○: Direct setting is possible, △: Position data or parameter input is required, —: The operation is not supported.
 (Note 1) This function is limited to the 24VAC servo motor specification.
 (Note 2) It returns to home position with the first movement command.
 (Note 3) It's possible when the movement command type of the parameter No.27 is set to 0.
 (Note 4) Select either the zone signal output or position zone signal output with parameter No.149.

I/O Signal Function Details

The following table shows functions assigned to the controller I/O.
 Set to the remote I/O mode and select the PIO patterns from 0-5.
 The controller can be operated by turning each port number ON/OFF via the network.

		Setting of the parameter No.25 of MCON									
		Positioning mode		Teaching mode		256-point mode		Solenoid valve mode 1		Solenoid valve mode 2	
		0		1		2		4		5	
Category	Port number	Code	Signal name	Code	Signal name	Code	Signal name	Code	Signal name	Code	Signal name
PLC output ↓ MCON input	0	PC1	Command position number	PC1	Command position number	PC1	Command position number	ST0	Start position 0	ST0	Start position 0
	1	PC2		PC2		PC2		ST1	Start position 1	ST1	Start position 1
	2	PC4		PC4		PC4		ST2	Start position 2	ST2	Start position 2
	3	PC8		PC8		PC8		ST3	Start position 3	-	Cannot be used
	4	PC16		PC16		PC16		ST4	Start position 4	-	
	5	PC32		PC32		PC32		ST5	Start position 5	-	
	6	-	MODE	Teaching mode command	PC64	ST6	Start position 6	-			
	7	-	Cannot be used	JISL	Jog/Inching switching	PC128	-	Cannot be used	-		
	8	-	JOG+	+Jog	-	Cannot be used	-	-	-		
	9	BKRL	Forced brake release	JOG-	-Jog	BKRL	Forced brake release	BKRL	Forced brake release	BKRL	Forced brake release
	10	-	Cannot be used	-	Cannot be used	-	Cannot be used	-	Cannot be used	-	Cannot be used
	11	HOME	Home return	HOME	Home return	HOME	Home return	HOME	Home return	-	
	12	#STP	Pausing	#STP	Pausing	#STP	Pausing	#STP	Pausing	-	
	13	CSTR	Positioning start	CSTR/ PWRT	Positioning start/ Position data capture command	CSTR	Positioning start	-	Cannot be used	-	
	14	RES	Reset	RES	Reset	RES	Reset	RES	Reset	RES	Reset
15	SON	Servo ON command	SON	Servo ON command	SON	Servo ON command	SON	Servo ON command	SON	Servo ON command	
MCON output ↓ PLC input	0	PM1	Completed position number	PM1	Completed position number	PM1	Completed position number	PE0	Position complete 0	LS0	Backward end movement command 0
	1	PM2		PM2		PM2		PE1	Position complete 1	LS1	Backward end movement command 1
	2	PM4		PM4		PM4		PE2	Position complete 2	LS2	Backward end movement command 2
	3	PM8		PM8		PM8		PE3	Position complete 3	-	Cannot be used
	4	PM16		PM16		PM16		PE4	Position complete 4	-	
	5	PM32		PM32		PM32		PE5	Position complete 5	-	
	6	MOVE	Moving signal	MOVE	Moving signal	PM64	PE6	Position complete 6	-		
	7	ZONE1	Zone 1	MODES	Teaching mode signal	PM128	ZONE1	Zone 1	ZONE1	Zone 1	
	8	PZONE/ ZONE2 (Note 1)	Position zone/ Zone 2	PZONE/ ZONE1	Position zone/ Zone 1	PZONE/ ZONE1	Position zone/ Zone 1	PZONE/ ZONE2	Position zone/ Zone 2	PZONE/ ZONE2	Position zone/ Zone 2
	9	-	Cannot be used	-	Cannot be used	-	Cannot be used	-	Cannot be used	-	Cannot be used
	10	HEND	Home return complete	HEND	Home return complete	HEND	Home return complete	HEND	Home return complete	HEND	Home return complete
	11	PEND	Positioning complete signal	PEND/ WEND	Positioning complete signal/ Position data capture completed	PEND	Positioning complete signal	PEND	Positioning complete signal	-	Cannot be used
	12	SV	Operation ready	SV	Operation ready	SV	Operation ready	SV	Operation ready	SV	Operation ready
	13	#EMGS	Emergency stop	#EMGS	Emergency stop	#EMGS	Emergency stop	#EMGS	Emergency stop	#EMGS	Emergency stop
	14	#ALM	Alarm	#ALM	Alarm	#ALM	Alarm	#ALM	Alarm	#ALM	Alarm
15	LOAD/ TRQS/ #ALML	Torque detection(Note 2)/ Minor failure output	#ALML	Minor failure output	LOAD/ TRQS/ #ALML	Torque detection(Note 2)/ Minor failure output	LOAD/ TRQS/ #ALML	Torque detection(Note 2)/ Minor failure output	#ALML	Minor failure output	

(Note 1) Can be switched by Parameter No. 149 "Zone output switching".

(Note 2) When the driver for stepper motor is selected, it can be switched by the Parameter No. 156 "Torque detection/Minor failure output".

Minor fault output is used for the 24VAC servo motor driver / BLDC servo motor driver.

* In the table above, the # symbol accompanying each code indicates a negative logic signal.

* PIO pattern 3 is not available.

General Specifications

Specification	Description							
Number of controlled axes	8 axes max.							
Controller/Motor input power supply voltage	24VDC \pm 10%							
Brake release power consumption current	0.15A \times number of axes							
Control power consumption current	1.0A							
Control power inrush current (Note 1)	5A max., 30ms or less							
Motor consumption current	Actuator type			Rating	Maximum			
	Pulse motor (Note 2)	RCP2	20P~28P		/	Power-saving	Standard/ Hi-accel./decel.	
		RCP3	28SP~56P			/	/	2.0A
		RCP4	28P~56P	High-output disabled		3.5A	/	2.2A
		RCP5 RCP6		High-output enabled (Note 3)			/	4.2A
	24VAC servo motor (Note 2)	2W		0.8A	/	/	4.6A	
		5W		1.0A	/	/	6.4A	
		10W (RCL)		1.3A	/	/	6.4A	
		10W (RCA/RCA2)		1.3A	2.5A	/	4.4A	
		20W		1.3A	2.5A	/	4.4A	
		20W (20S type)		1.7A	3.4A	/	5.1A	
	BLDC servo motor	3W		0.7A	/	/	1.5A	
Motor power inrush current (Note 1)	Slot numbers \times 10A max., 5ms or less							
Motor-encoder cable length	20m max. *When the simple absolute is selected, 10m will be the maximum length.							
Serial communication (SIO port: teaching only)	RS485: 1ch (Modbus protocol) Speed: 9.6~230.4kbps							
External interface	DeviceNet, CC-Link, PROFIBUS-DP, CompoNet, EtherCAT, EtherNet/IP, PROFINET IO							
Data setting, input method	PC compatible software, touch panel teaching pendant, gateway parameter setting tool							
Data retention memory	Position data and parameters are saved in non-volatile memory. (No limit to rewrite)							
Number of positioning points	256 points (Unlimited for simple numerical control and direct numerical control) (* The number of positioning points vary depending on the motion mode selection set by the parameter.							
LED display (installed on the front panel)	Status LED for driver: 8 LEDs (for each driver board) Status LED for fieldbus: 7 LEDs							
Electromagnetic brake force release	Enable to force-release by transmitting a deactivation signal to each axis (24VDC input).							
Protection function (Note 4)	Overcurrent protection (each slot has its own solid-state motor cut-off circuit built-in)							
Electric shock protection mechanism	Class I, basic insulation							
Insulation resistance	500VDC 10M Ω							
Weight	620/ 690g when the simple absolute spec. is selected /Additional 1950g when used with the absolute battery box (8-axis spec.)							
Cooling method	Forced air cooling							
External dimensions	123W \times 115H \times 95D							
Ambient operating temp. & humidity	0~40°C, 85% RH or less (Non-condensing)							
Vibration resistance	Frequency: 10~57Hz/Amplitude: 0.075mm, Frequency: 57~150Hz/Acceleration: 9.8m/s ² XYZ directions, Sweep time: 10 minutes, Number of sweeps:10 times							
Impact resistance	Drop height: 800mm 1 corner, 3 edges, 6 faces							
Degree of protection	IP20							

(Note 1) Please note that the inrush current value varies depending on the impedance of the power line.

(Note 2) The current will be highest in the exciting phase detection performed in the first servo ON process after the power is turned on.

(Pulse motor: 100ms (normal)/24VAC servo motor: approx. 1~2 seconds (normal), up to 10 seconds)

(Note 3) The driver board of high-output configuration specification can be used to control one axis per slot.

(Note 4) The 24VAC servo motor will function if the load current reaches equal to or greater than 1.4 times the maximum value.

Name of Each Component

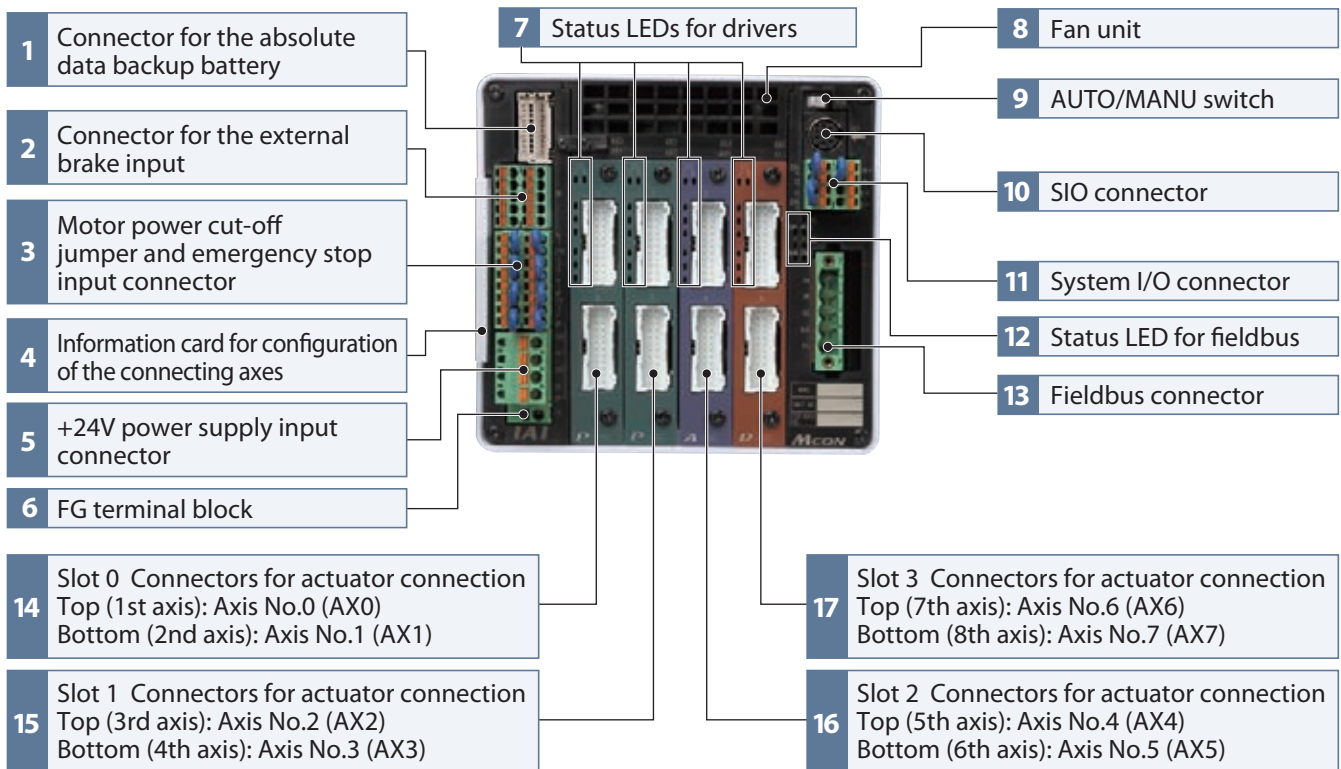

■ Descriptions of Each Component

- 1 Connector for the absolute data backup battery**
This connects the absolute data backup battery box should the controller be the simple absolute type.
- 2 Connector for the external brake input**
This signal input connector is used to release the actuator brake externally.
- 3 Motor power cut-off jumper and emergency stop input connector**
In/out terminals for external relay for motor power cut-off and connectors for emergency stop input, for each slot (2 axes).
- 4 Information card for configuration of the connecting axes**
The information card contains information regarding the configuration of the controller axes which is removable to examine the contents.
- 5 +24V power supply input connector**
This is the main power supply connector for the controller:
Motor drive shut-off is possible while restoring power to the controller unit after an emergency stop.
This is because the power supply terminals for the motor and the controller are separate.
- 6 FG terminal block**
It is a terminal block for frame ground.
- 7 Status LEDs for drivers**
The driver status and absolute status are displayed per slot (2 axes).
- 8 Fan unit**
A fan unit that can be easily replaced. (Replacement fan unit Model: MSEP-FU)
- 9 AUTO/MANU switch**
A switch for the automatic / manual operation.
- 10 SIO connector**
A connector for connecting the teaching pendant and PC compatible software cable.
- 11 System I/O connector**
The connector for remote AUTO/MANU switch input and emergency stop input for the entire controller with functions including an external regeneration-resistance expansion terminal and an external SIO terminal.
- 12 Status LEDs for fieldbus**
Status display LEDs for controller and fieldbus.
- 13 Fieldbus connector**
Equipped with a connector for connecting various fieldbus.
- 14 ~ 17 Motor-encoder connectors for actuator connections**
Connect motor-encoder cables for actuators.

External Dimensions

Controller

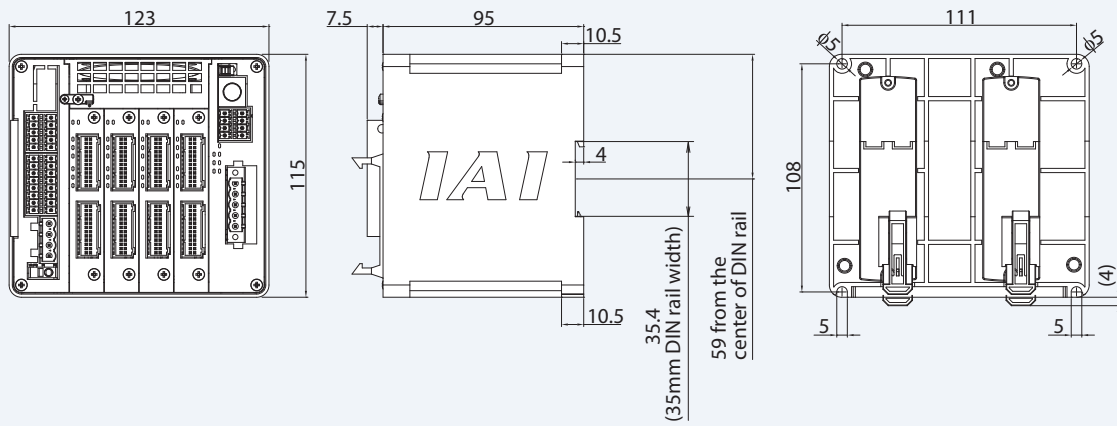

Absolute battery box

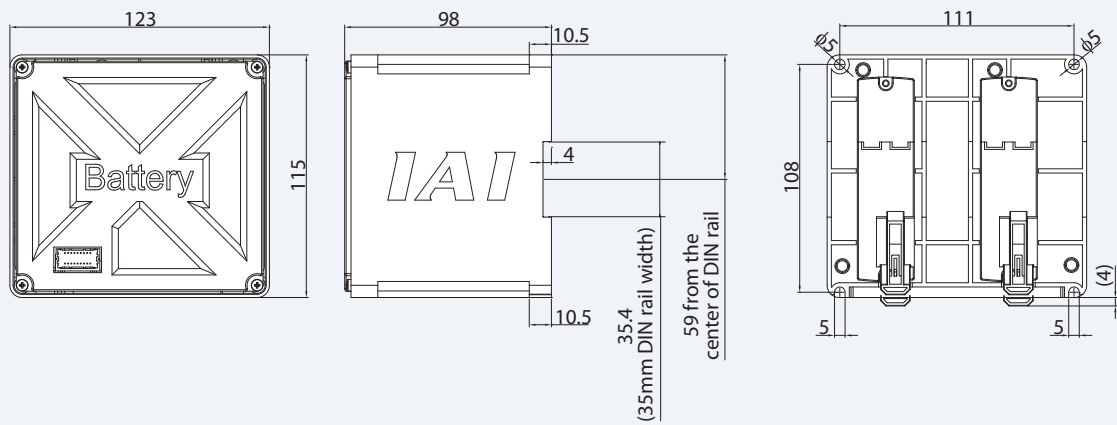

Options

Teaching pendant

Features A teaching device equipped with functions such as position teaching, trial operation, and monitoring.

Model TB-02-C

Configuration

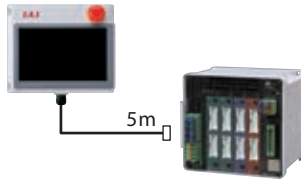

External dimensions

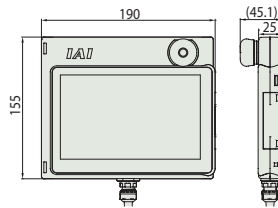

Specifications

Rated voltage	24VDC
Power consumption	3.6W or less (150mA or less)
Ambient operating temperature	0~40°C
Ambient operating humidity	20~85% RH (Non-condensing)
Environmental resistance	IP20
Weight	470g (TB-02 box only)

PC compatible software (Windows only) * The PC compatible software is required for the MCON.

Features The start-up support software which comes equipped with functions such as position teaching, trial operation, and monitoring. A complete range of functions needed for making adjustments contributes to a reduced start-up time.

Compatible with Windows XP SP2 or later/Vista/7/8

Model RCM-101-MW (with an external device communication cable + RS232 conversion unit)

MCON is compatible with Ver.10.00.00.00 or later.

Configuration

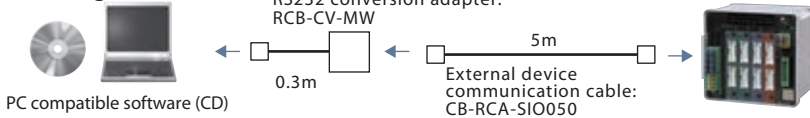

Model RCM-101-USB (with an external device communication cable + USB conversion adapter + USB cable)

MCON is compatible with Ver.10.00.00.00 or later.

Configuration

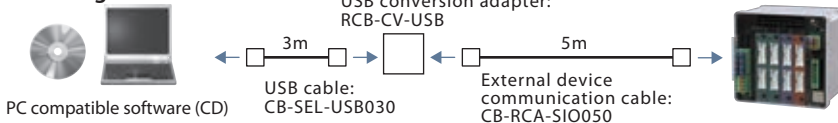

External regeneration resistor

Overview

As the motor reduces its speed, the resistor will convert dissipated regenerative current into heat. Since the MCON controller has a built-in regeneration resistor, this can be used for normal operations. However, an external resistor can be installed should the capacity of the internal resistor be insufficient.

Model RER-1

External Dimensions

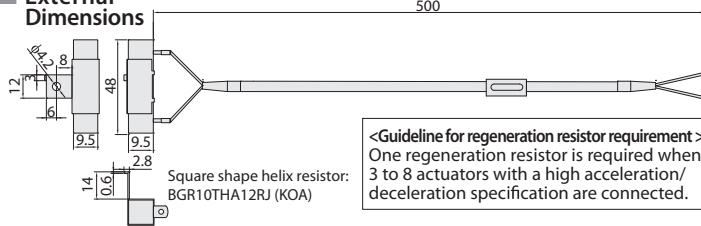

Absolute battery box

Overview

If the simple absolute specification is selected with code ABB, the absolute battery box is included with the controller. However, if the battery box is ordered as a separate unit, it does not include the battery but just the box itself. If the battery is needed, please purchase it separately. (Model: AB-7).

Model MSEP-ABB
(Battery sold separately)

External Dimensions See P.15

* Cable that connects the absolute battery box and MCON (Cable Model: CB-MSEP-AB005) comes with the absolute battery box.

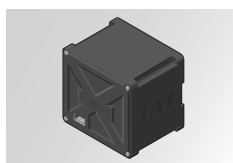

Dummy plug

Overview

It is required for the safety category compliant type (CG).

Model DP-5



Driver board

Overview

The driver board can be supplemented or exchanged in the MCON controller. When just the actuator operated needs to be modified, this can be done by simply replacing the driver board instead of the entire controller. (The parameters will need to be adjusted when the driver board is replaced)

Model

Motor type	High output type	Encoder type	Number of axes	Model number
Pulse motor	High-output setting enabled	Battery-less absolute/ Incremental	1	MCON-PPD1-W
		Simple absolute	1	MCON-PPD1-A
	High-output Setting disabled	Battery-less absolute/ Incremental	1	MCON-PD1-W
		Simple absolute	2	MCON-PD1-A
24VAC servo motor	-	Battery-less absolute/ Incremental	1	MCON-AD1-W
			2	MCON-AD2-W
		Simple absolute	1	MCON-AD1-A
			2	MCON-AD2-A
BLDC servo motor	-	Incremental	1	MCON-DD1-I
			2	MCON-DD2-I

Replacement battery

Overview

Replacement battery used with the absolute battery box.

Model AB-7



Replacement fan unit

Model MSEP-FU

For RCP2

Model Number **CB-PSEP-MPA** Robot cable

Only robot cable is available for this model.

* Please indicate the cable length (L) in , maximum 20m, E.g.) 080 = 8m

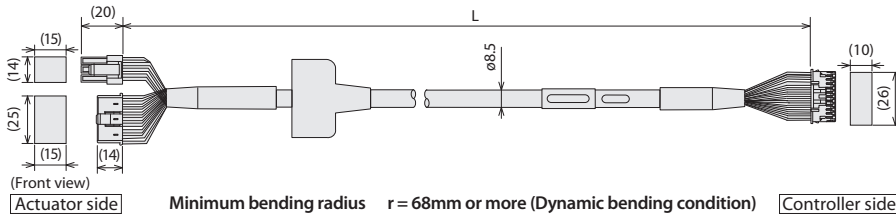

Actuator side Terminal number		Controller side Terminal number
1	[φA]	1
2	[VMM]	2
4	[φB]	3
5	[VMM]	4
6	[φA]	5
16	[φB]	6
17	[BK+]	9
5	[BK-]	10
6	NC	11
13	NC	12
14	[LS+]	7
1	[A+]	8
2	[A-]	13
3	[B+]	14
4	[B-]	15
10	[VCC]	16
11	[VPS]	17
9	[GND]	18
12	[reserve]	19
15	NC	20
7	NC	21
8	NC	22
18	Shield [FG]	23
		24

For RCP2-RTBS/RTBSL/RTCS/RTCSL

Model Number **CB-RPSEP-MPA** Robot cable

Only robot cable is available for this model.

* Please indicate the cable length (L) in , maximum 20m, E.g.) 080 = 8m

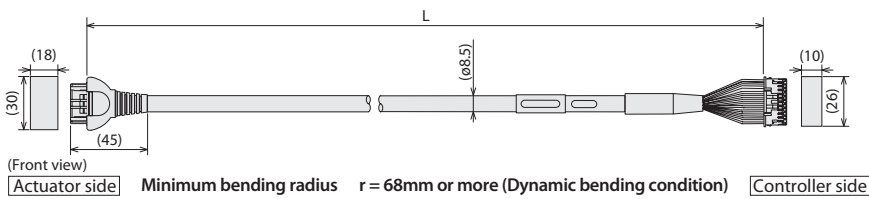

Actuator side Terminal number		Controller side Terminal number
A1	[φA]	1
B1	[VMM]	2
A2	[φA]	5
B2	[φB]	3
A3	[VMM]	4
B3	[φB]	6
A6	[LS+]	7
B6	[LS-]	8
A7	[A+]	13
B7	[A-]	14
A8	[B+]	15
B8	[B-]	16
A4	NC	-
B4	NC	-
A5	[BK+]	9
B5	[BK-]	10
A9	[GNDLS]	20
B9	[VPS]	18
A10	[VCC]	17
B10	[GND]	19
A11	NC	21
B11	Shield [FG] (FG)	24
	NC	22
	NC	23

For RCA

Model Number **CB-ASEP2-MPA** Robot cable

Only robot cable is available for this model.

* Please indicate the cable length (L) in , maximum 20m, E.g.) 080 = 8m

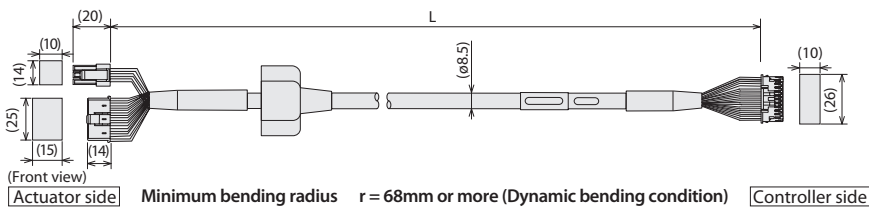

Actuator side Terminal number		Controller side Terminal number
1	[U]	1
2	[V]	2
	NC	3
	NC	4
3	[W]	5
	NC	6
18	[BK+]	7
17	[BK-]	8
7	[LS+]	9
16	[LS-]	10
1	[A+]	11
2	[A-]	12
3	[B+]	13
4	[B-]	14
10	[Z+]	15
11	[Z-]	16
14	[VCC]	17
13	[VPS]	18
15	[GND]	19
6	[reserve]	20
5	NC	21
8	NC	22
12	NC	23
9	Shield [FG]	24

MCON Series
Catalogue No. 0916-E



The information contained in this catalog is subject to change without notice for the purpose of product improvement



IAI Industrieroboter GmbH

Ober der Röth 4

D-65824 Schwalbach / Frankfurt

Germany

Tel.: +49-6196-8895-0

Fax: +49-6196-8895-24

E-Mail: info@IAI-GmbH.de

Internet: <http://www.eu.IAI-GmbH.de>

IAI America, Inc.

2690 W. 237th Street, Torrance, CA 90505, U.S.A

Phone: +1-310-891-6015, Fax: +1-310-891-0815

IAI (Shanghai) Co., Ltd

Shanghai Jiahua Business Center A8-303, 808,

Hongqiao Rd., Shanghai 200030, China

Phone: +86-21-6448-4753, Fax: +86-21-6448-3992

IAI CORPORATION

577-1 Obane, Shimizu-Ku, Shizuoka, 424-0103 Japan

Phone: +81-543-64-5105, Fax: +81-543-64-5192

IAI Robot (Thailand) Co., Ltd

825 PhairojKijja Tower 12th Floor, Bangna-Trad RD.,

Bangna, Bangna, Bangkok 10260, Thailand

Phone: +66-2-361-4457, Fax: +66-2-361-4456